

# VANTAA CUP



## VANTAA (FIN)

2014-11-15 - 2014-11-16 2014

Résultats - Results

Lutte Greco-Romaine - Greco-Roman



**Liste des arbitres / Referee list****Vantaa Cup**

<b>N°</b>	<b>Licence</b>	<b>Pays Country</b>	<b>Nom - Last Name</b>	<b>Prénom - First Name</b>
	5348	EST	TREIMAN	Marek
	4594	FIN	AALTO	Anni-Maija
	4985	FIN	HIETALA	Joonas
	3875	FIN	KOIVULAHTI	Jukka
	3874	FIN	KOIVUSALO	Jari
	4275	FIN	KUNTTU	Juha
	5280	FIN	KURONEN	Jali
	4639	FIN	KYLMÄ,,NIEMI	Kirsi
	4220	FIN	PETROVIC	Stevo
	3793	FIN	PILLI	Ilmo
	2083	FIN	TOIVOLA	Karri
	4301	FIN	TYNNINEN	Eero
	4435	FIN	VÄ,,NTSI	Antti
	2082	FIN	VEHVILÄ,,INEN	Pertti
	3966	FIN	VUORI	Mika
	4987	FIN	YLIMÄ,,KI	Susanna
	3414	ITA	MASI	Marco
	4647	ITA	PRATICO	Guido
	3757	RUS	DAVIDYAN	Grigori
	4996	RUS	KOVALENKO	Sergei
	4989	RUS	YULTIMIROV	Boris
	5253	SWE	TAAVELA	Katja
	5461	UKR	VOLOSHYN	Vitalii

Nombre d'arbitres - Number of Referee

23



## Liste des nations / Countries List

### Vantaa Cup

STYLE GR



#### *Pays - Country*

	Ä,,Ä,,NEKOSKEN HUIMA	Ä,,H
	ALAVUDEN URHEILIJAT	AU
	ESTONIA	EST
	FINLAND	FIN
	HELSINGIN TARMO	HeTa
	ILMAJOEN KISAILIJAT	IK
	ITALY	ITA
	JÄ,,RVENPÄ,,Ä,,N VOIMAILIJAT	JÄαVo
	KOOVEE	Koovee
	KUORTANEEN KUNTO	KuKu
	LAHDEN AHKERA	LA
	LAPIN VEIKOT	LapinV
	LATVIA	LAT
	OULUN PYRINTÄ-	OP
	PORIN PAINI-MIEHET	PPM
	RUSSIA	RUS
	SAINT PETERSBURG	StP
	SEINÄ,,JOEN PAINI-MIEHET	SPM
	UKRAINE	UKR
	YLÄ,,-TIKKURILAN KIPINÄ,,	YTK

Nombre de nations - Number of Countries

**Nombre d'engagés par nation / Number of Entries By Country****Vantaa Cup****STYLE GR**

<b>Pays - Country</b>	<b>130 KG</b>	<b>59 KG</b>	<b>66 KG</b>	<b>71 KG</b>	<b>75 KG</b>	<b>80 KG</b>	<b>85 KG</b>	<b>98 KG</b>	<b>TOTAL</b>
Ã,,H							1		1
AU					1				1
EST	1	1	1		1		2	1	7
FIN	1	1	1	1	1	1	1	1	8
HeTa			1						1
IK		1	1	1	1	1	1		6
ITA		1	1		3		1		6
JÃ¤Vo			1					1	2
Koovee			1	1					2
KuKu			1						1
LA					1				1
LapinV			1						1
LAT					1				1
OP				1		1		1	3
PPM			1						1
RUS	1	1	1	1		2	2	1	9
SPM		1							1
StP	1				2		1	1	5
UKR		1			1		1	1	4
YTK				2				1	3
<b>TOTAL</b>	<b>4</b>	<b>7</b>	<b>11</b>	<b>7</b>	<b>12</b>	<b>5</b>	<b>10</b>	<b>8</b>	<b>64</b>

**Nombre de nations - Number of Countries** **20**



## Liste des Engagés par pays / Entry-List By Country

### Vantaa Cup

STYLE GR



#### ESTONIA (EST)

##### Lutteur(s) / Wrestler(s) :

130 kg	MAATEN, Kaarel
59 kg	PIISKOPPEL, Taaniel
66 kg	NAARITS, Madis
75 kg	TÄ-GEN, Silver
85 kg	LIITMÄ,,E, Raido TOOM, Alo
98 kg	APS, Eerik

#### FINLAND (FIN)

##### Lutteur(s) / Wrestler(s) :

###### Ä,H

85 kg PÄ-LKKI, Leo

###### AU

75 kg PALOMÄ,,KI, Henri

###### FIN

130 kg HUOVINEN, Juuso  
59 kg SHIRMOHAMMADI, Mazyar  
66 kg ZAKOLE, Jumaa  
71 kg HIRVI, Lari  
75 kg KOIVULAHTI, Arttu  
80 kg UOTILA, Olli  
85 kg MÄ,,KINEN, Antti  
98 kg KALLIO, Timo

###### HeTa

66 kg PITKÄ,,NEN, Jerry

###### IK

59 kg LATVALA, Juuso  
66 kg LIPASTI, Matias  
71 kg ERKKOLA, Niko  
75 kg ROPPONEN, Vili  
80 kg METSOMÄ,,KI, Toni  
85 kg KIVIMÄ,,KI, Marko

###### JÄVo

66 kg OJALA, Toni  
98 kg KUOSMANEN, Elias

###### Koovee

66 kg NIEMISTÄ-, Jussi-Pekka  
71 kg PUROLAINEN, Sakke



## Liste des Engagés par pays / Entry-List By Country



### Vantaa Cup

STYLE GR

#### KuKu

66 kg LYTTINEN, Mikko

#### LA

75 kg JAAKKOLA, Markus

#### LapinV

66 kg MÄ„HÄ–NEN, Lauri

#### OP

71 kg Ä–ZYAVUZ, Sami

80 kg KARJALAINEN, Janne

98 kg JOKELA, Jonne

#### PPM

66 kg KALLIOLEVO, Arttu

#### SPM

59 kg SYRJÄ„, Rami

#### YTK

71 kg HALONEN, Ville

JÄ„RVINEN, Esa

98 kg LAHTI, Tuomas

### ITALY (ITA)

#### Lutteur(s) / Wrestler(s) :

59 kg MARVICE, Ruben

66 kg CASCAVILLA, Davide

75 kg DARIOZZI, Luca  
MAFFEZZOLI, Matteo  
RUSSO, Ciro

85 kg PARISI, Fabio

### LATVIA (LAT)

#### Lutteur(s) / Wrestler(s) :

75 kg KOLCOVS, Jevgenijs

### RUSSIA (RUS)

#### Lutteur(s) / Wrestler(s) :

#### RUS

130 kg SHCHUR, Vitalii

59 kg TATARINOV, Ivan

66 kg ABDULLIN, Aslan

71 kg GRIGORYAN, Narek



## Liste des Engagés par pays / Entry-List By Country

### Vantaa Cup

STYLE GR



80 kg	SHARAFETDINOV, Imil YUSIPOV, Roman
85 kg	BIKBAEV, Azamat SKRYABIN, Alexey
98 kg	MAGOMEDOV, Kantemir
<u>StP</u>	
130 kg	CHESNOKOV, Sergey
75 kg	CHERNOV, Ivan ISAKOV, Ruslan
85 kg	DUGUCHIEV, Movsar
98 kg	SAFARYAN, Maksim

### UKRAINE (UKR)

#### Lutteur(s) / Wrestler(s) :

59 kg	SHEVTSOV, Anton
75 kg	PYSHKOV, Dmytro
85 kg	SHKRIUBA, Iurii
98 kg	SAVETA, Yevhenii



# Feuille de compétition / Competition Sheet

## Vantaa Cup

STYLE : GR 130 kg



### TOUR : 1

1	$\frac{1}{4}$	HUOVINEN Juuso (FIN)	P1	P2	P3	}	2	MAATEN Kaarel (EST)
			4	0	0			
2	$\frac{3}{7}$	MAATEN Kaarel (EST)	P1	P2	P3	}		
			7	0	0			
3	$\frac{3}{3}$	SHCHUR Vitalii (RUS)	P1	P2	P3	}	3	SHCHUR Vitalii (RUS)
			3	0	0			
4	$\frac{0}{0}$	CHESNOKOV Sergey (StP)	P1	P2	P3	}		
			0	0	0			

### TOUR : 2

1	$\frac{0}{0}$	HUOVINEN Juuso (FIN)	P1	P2	P3	}	3	SHCHUR Vitalii (RUS)
			0	0	0			
3	$\frac{4}{8}$	SHCHUR Vitalii (RUS)	P1	P2	P3	}		
			8	0	0			
2	$\frac{0}{0}$	MAATEN Kaarel (EST)	P1	P2	P3	}	4	CHESNOKOV Sergey (StP)
			0	0	0			
4	$\frac{4}{4}$	CHESNOKOV Sergey (StP)	P1	P2	P3	}		
			4	0	0			

### TOUR : 3

1	$\frac{1}{2}$	HUOVINEN Juuso (FIN)	P1	P2	P3	}	4	CHESNOKOV Sergey (StP)
			2	0	0			
4	$\frac{3}{4}$	CHESNOKOV Sergey (StP)	P1	P2	P3	}		
			4	0	0			
2	$\frac{1}{1}$	MAATEN Kaarel (EST)	P1	P2	P3	}	3	SHCHUR Vitalii (RUS)
			1	0	0			
3	$\frac{3}{4}$	SHCHUR Vitalii (RUS)	P1	P2	P3	}		
			4	0	0			

### Classement

Cl	Pays	Nom	Points
1	RUS	SHCHUR Vitalii	10
2	StP	CHESNOKOV Sergey	7
3	EST	MAATEN Kaarel	4
4	FIN	HUOVINEN Juuso	2





**Classement**

**Vantaa Cup**

STYLE : GR 130 kg



**1 - Or / Gold**



SHCHUR Vitalii

**2 - Argent / Silver**



CHESNOKOV Sergey

**3 - Bronze**



MAATEN Kaarel

<i>Classement</i>	<i>Nom - Name</i>	<i>Pays - Country</i>	<i>Points</i>
1	SHCHUR Vitalii	RUS	10
2	CHESNOKOV Sergey	StP	7
3	MAATEN Kaarel	EST	4
4	HUOVINEN Juuso	FIN	2



# Feuille de compétition / Competition Sheet

## Vantaa Cup



STYLE : GR 59 kg

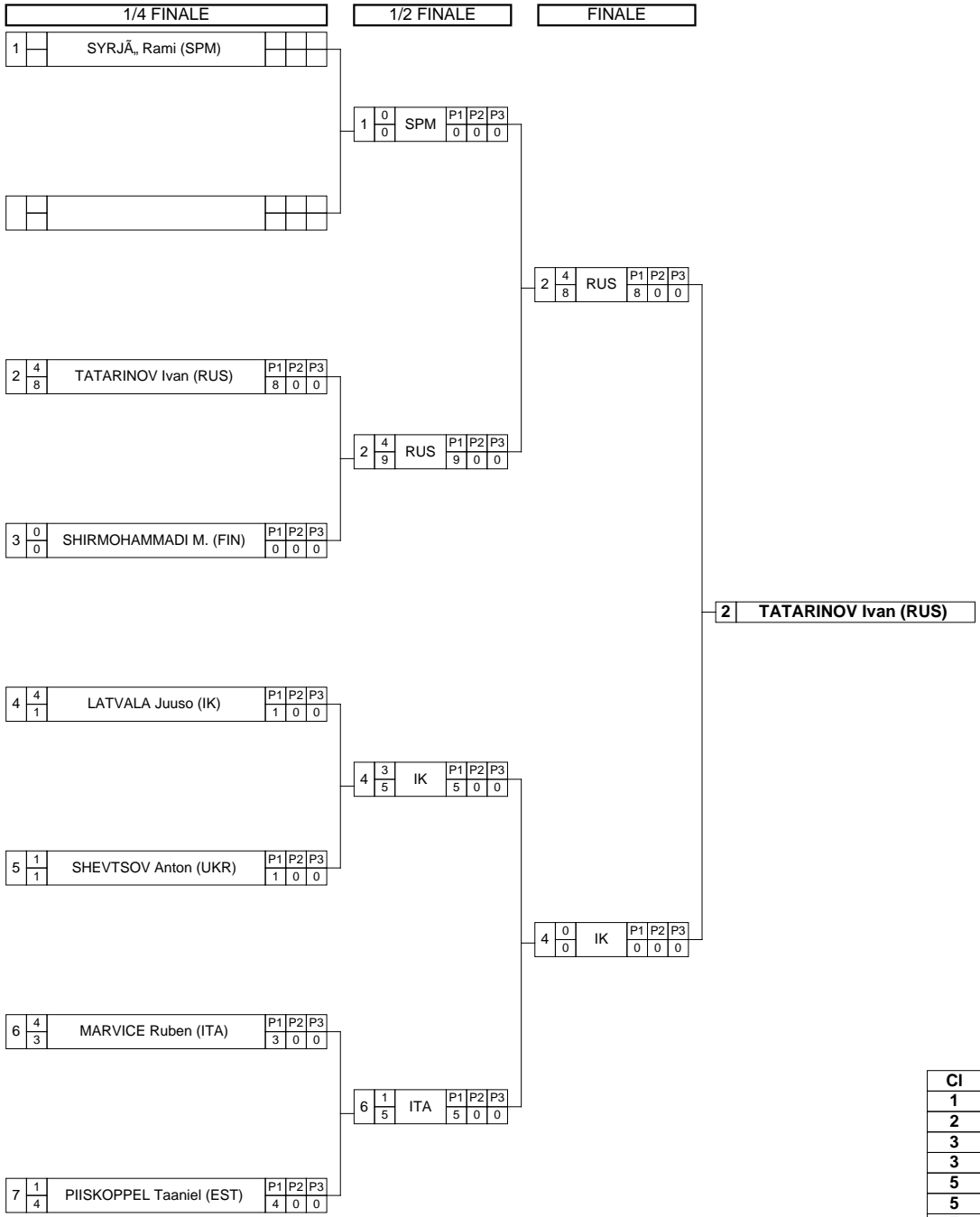

**Classement**

Cl	Pays	Nom
1	RUS	TATARINOV Ivan
2	IK	LATVALA Juuso
3	SPM	SYRJÄ,, Rami
3	UKR	SHEVTSOV Anton
5	FIN	SHIRMOHAMMADI M.
5	ITA	MARVICE Ruben
7	EST	PIISKOPPEL Taaniel

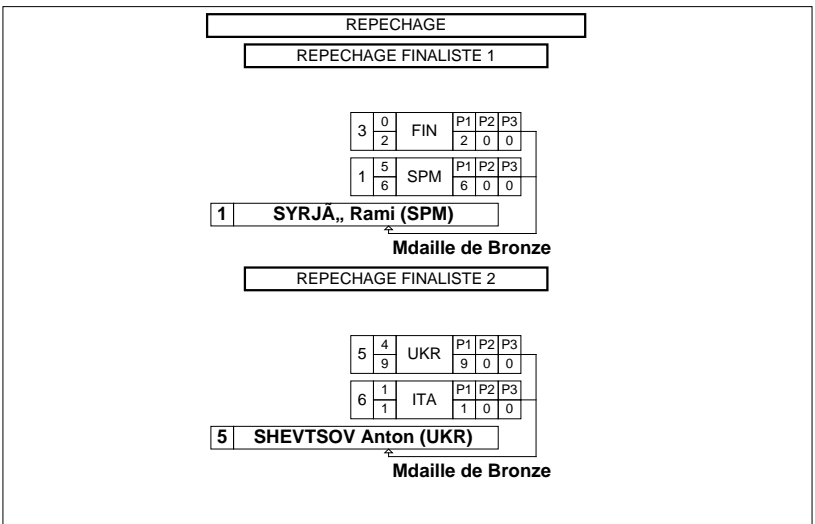



**Classement**

**Vantaa Cup**



STYLE : GR 59 kg

1 - Or / Gold



TATARINOV Ivan

2 - Argent / Silver



LATVALA Juuso

3 - Bronze



SYRJÄ,, Rami



SHEVTSOV Anton

<i>Classement</i>	<i>Nom - Name</i>	<i>Pays - Country</i>
1	TATARINOV Ivan	RUS
2	LATVALA Juuso	IK
3	SYRJÄ,, Rami	SPM
3	SHEVTSOV Anton	UKR
5	SHIRMOHAMMADI M.	FIN
5	MARVICE Ruben	ITA
7	PIISKOPPEL Taaniel	EST



# Feuille de compétition / Competition Sheet

## Vantaa Cup

STYLE : GR 66 kg

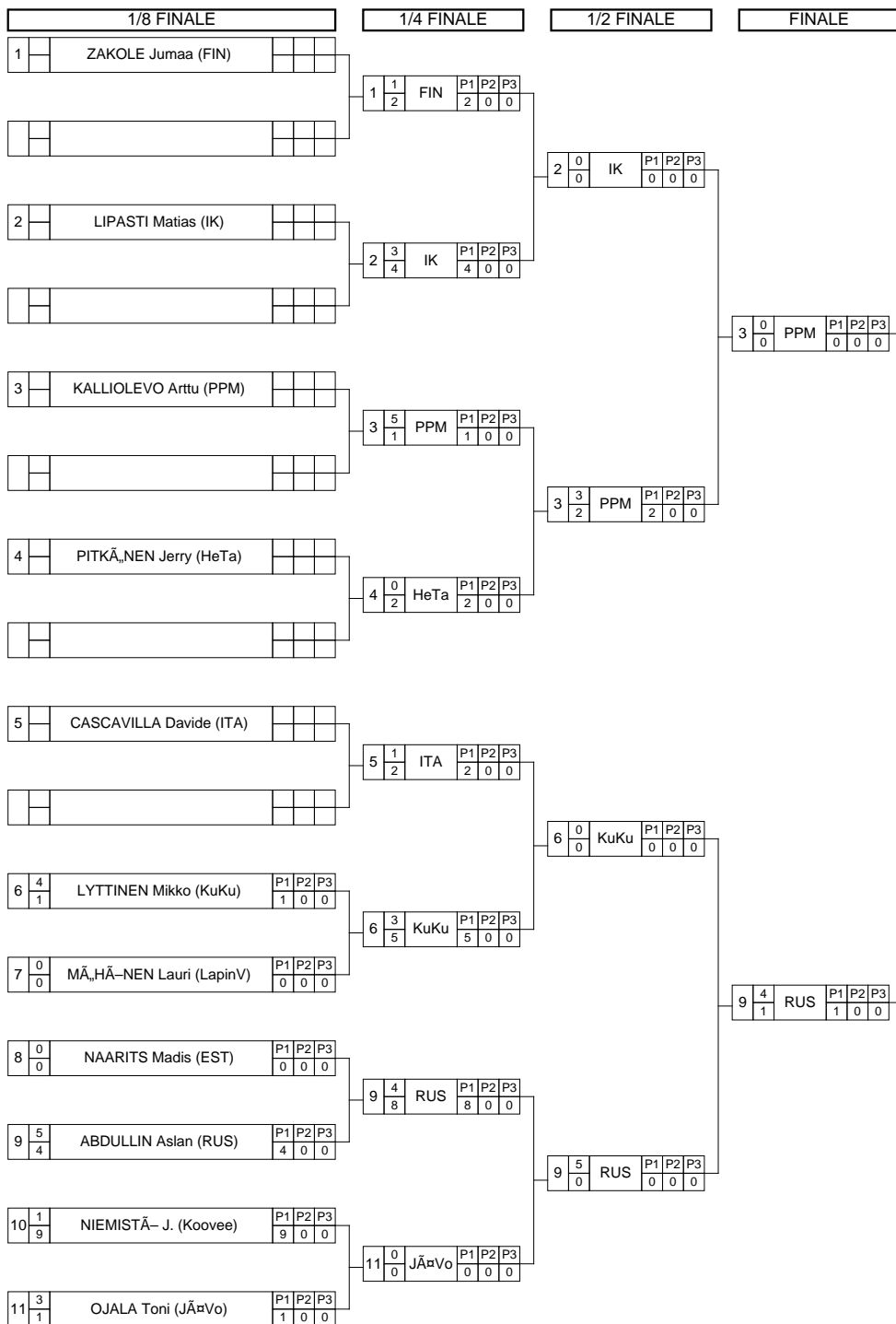

9 ABDULLIN Aslan (RUS)

### Classement

Cl	Pays	Nom
1	RUS	ABDULLIN Aslan
2	PPM	KALLIOLEVO Arttu
3	IK	LIPASTI Matias
3	JÄVo	OJALA Toni
5	HeTa	PITKÄ,NEN Jerry
5	KuKu	LYTTINEN Mikko
7	Koovee	NIEMISTÄ- J.
8	FIN	ZAKOLE Jumaa
9	ITA	CASCAVILLA Davide
10	EST	NAARITS Madis

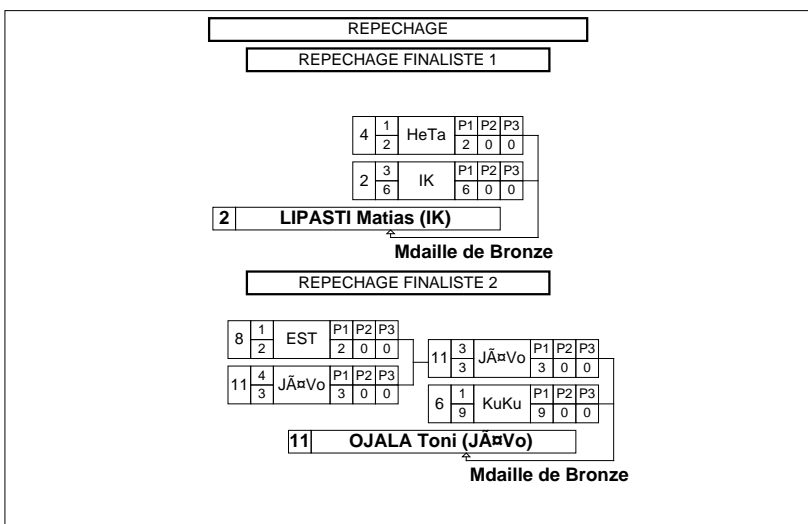



**Classement**

**Vantaa Cup**



STYLE : GR 66 kg

1 - Or / Gold



ABDULLIN Aslan

2 - Argent / Silver



KALLIOLEVO Arttu

3 - Bronze



LIPASTI Matias



OJALA Toni

<i>Classement</i>	<i>Nom - Name</i>	<i>Pays - Country</i>
1	ABDULLIN Aslan	RUS
2	KALLIOLEVO Arttu	PPM
3	LIPASTI Matias	IK
3	OJALA Toni	JÃ¤rvo
5	PITKÄ,,NEN Jerry	HeTa
5	LYTTINEN Mikko	KuKu
7	NIEMISTÄ- Jussi-Pekka	Koovee
8	ZAKOLE Jumaa	FIN
9	CASCAVILLA Davide	ITA
10	NAARITS Madis	EST



# Feuille de compétition / Competition Sheet

## Vantaa Cup



STYLE : GR 71 kg

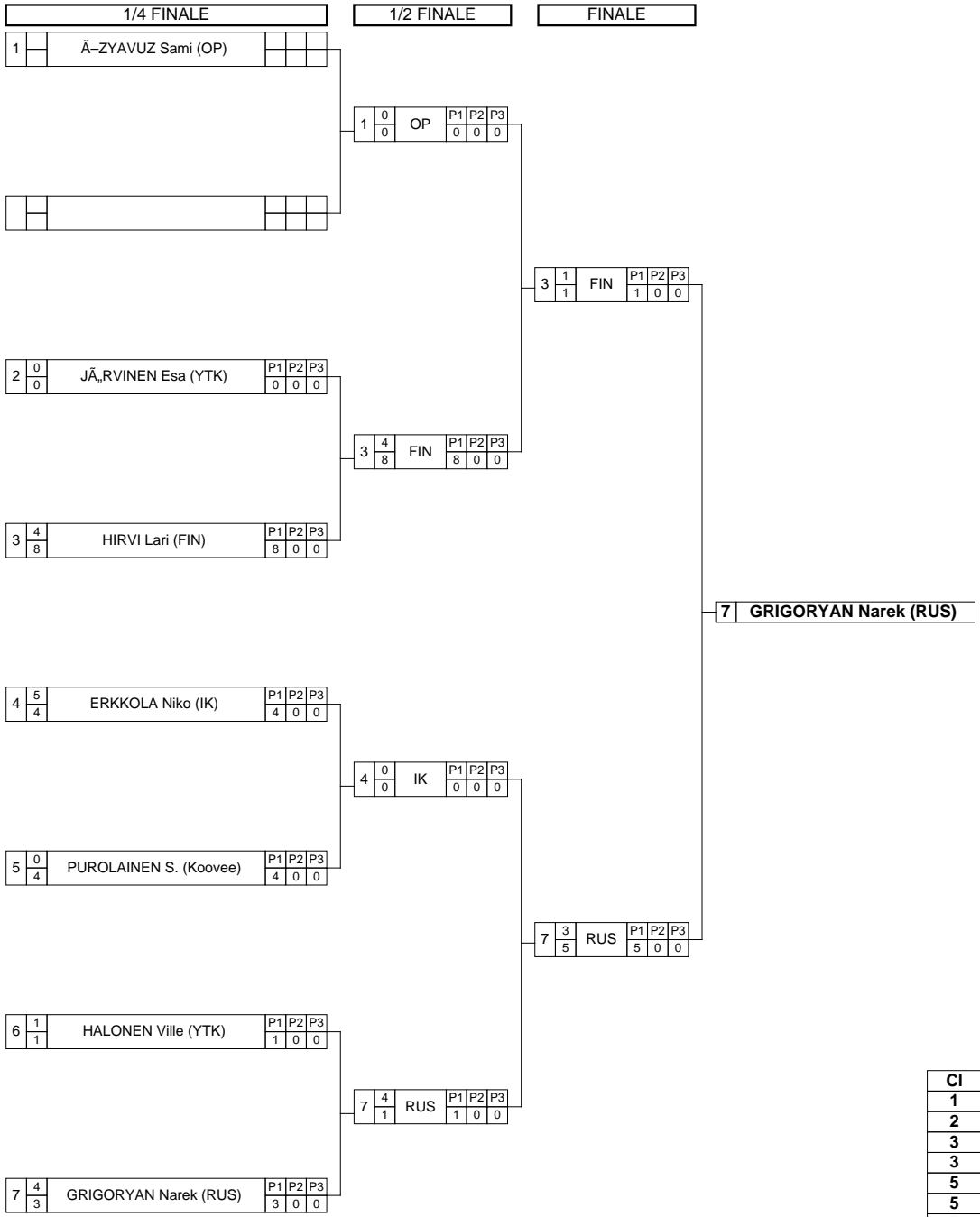

Classement

Cl	Pays	Nom
1	RUS	GRIGORYAN Narek
2	FIN	HIRVI Lari
3	OP	Ä-ZYAVUZ Sami
3	IK	ERKKOLA Niko
5	YTK	JÄ,,RVINEN Esa
5	YTK	HALONEN Ville
7	Koovee	PUROLAINEN Sakke

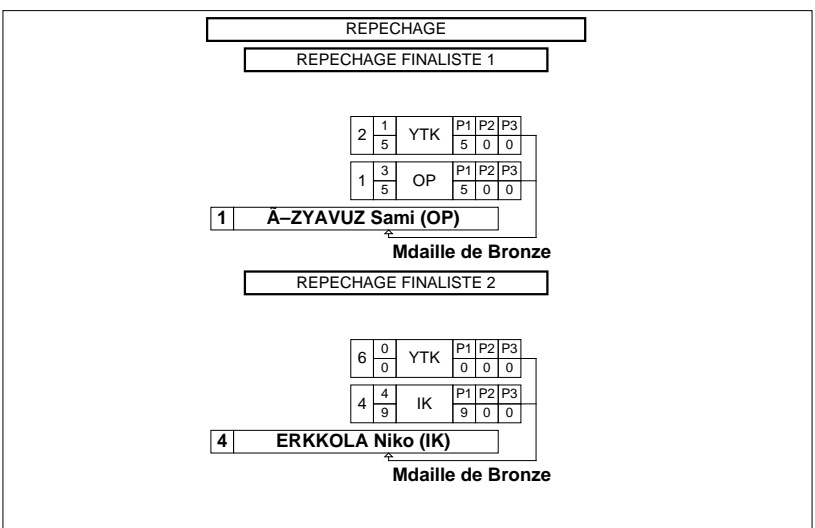



Classement

Vantaa Cup

STYLE : GR 71 kg



1 - Or / Gold



GRIGORYAN Narek

2 - Argent / Silver



HIRVI Lari

3 - Bronze



Ä-ZYAVUZ Sami



ERKKOLA Niko

Classement	Nom - Name	Pays - Country
1	GRIGORYAN Narek	RUS
2	HIRVI Lari	FIN
3	Ä-ZYAVUZ Sami	OP
3	ERKKOLA Niko	IK
5	JÄRVINEN Esa	YTK
5	HALONEN Ville	YTK
7	PUROLAINEN Sakke	Koovee



# Feuille de compétition / Competition Sheet

## Vantaa Cup

STYLE : GR 75 kg



8 PYSHKOV Dmytro (UKR)

### Classement

Cl	Pays	Nom
1	UKR	PYSHKOV Dmytro
2	StP	CHERNOV Ivan
3	ITA	RUSSO Ciro
3	StP	ISAKOV Ruslan
5	FIN	KOIVULAHTI Arttu
5	AU	PALOMÄKI Henri
7	LAT	KOLCOVS Jevgenijs
8	LA	JAAKKOLA Markus
9	EST	TĀ-GEN Silver
10	IK	ROPPONEN Vili
11	ITA	MAFFEZZOLI Matteo
12	ITA	DARIOZZI Luca

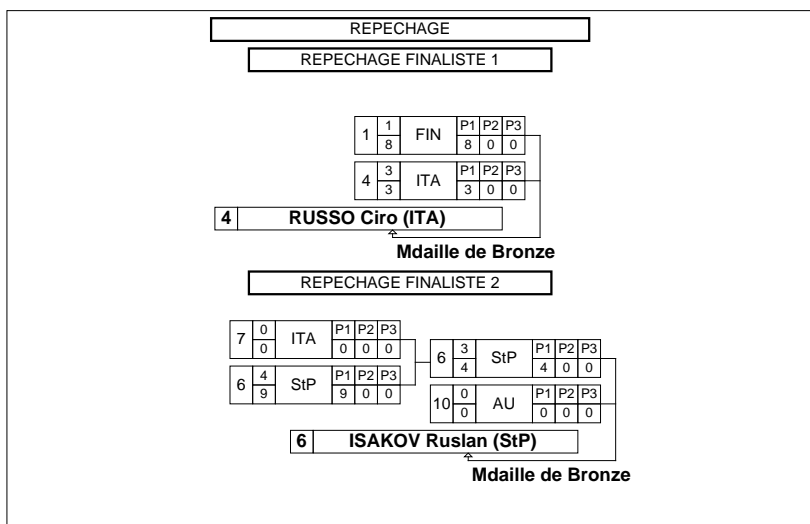



**Classement****Vantaa Cup**

STYLE : GR 75 kg

**1 - Or / Gold**

PYSHKOV Dmytro

**2 - Argent / Silver**

CHERNOV Ivan

**3 - Bronze**

RUSSO Ciro



ISAKOV Ruslan

<i>Classement</i>	<i>Nom - Name</i>	<i>Pays - Country</i>
1	PYSHKOV Dmytro	UKR
2	CHERNOV Ivan	StP
3	RUSSO Ciro	ITA
3	ISAKOV Ruslan	StP
5	KOIVULAHTI Arttu	FIN
5	PALOMÄKI Henri	AU
7	KOLCOVS Jevgenijs	LAT
8	JAAKKOLA Markus	LA
9	TÄGEN Silver	EST
10	ROPPONEN Vili	IK
11	MAFFEZZOLI Matteo	ITA
12	DARIOZZI Luca	ITA



# Feuille de compétition / Competition Sheet

## Vantaa Cup

STYLE : GR 80 kg



### TOUR : 1

1	$\frac{3}{2}$	SHARAFETDINOV Imil (RUS)	P1	P2	P3	1	SHARAFETDINOV Imil (RUS)
			2	0	0		
2	$\frac{0}{0}$	YUSIPOV Roman (RUS)	P1	P2	P3		
			0	0	0		
3	$\frac{4}{3}$	METSOMÄ,,KI Toni (IK)	P1	P2	P3	3	METSOMÄ,,KI Toni (IK)
			3	0	0		
4	$\frac{0}{2}$	KARJALAINEN Janne (OP)	P1	P2	P3		
			2	0	0		

### TOUR : 2

5	$\frac{0}{0}$	UOTILA Olli (FIN)	P1	P2	P3	1	SHARAFETDINOV Imil (RUS)
			0	0	0		
1	$\frac{4}{9}$	SHARAFETDINOV Imil (RUS)	P1	P2	P3		
			9	0	0		
2	$\frac{4}{9}$	YUSIPOV Roman (RUS)	P1	P2	P3	2	YUSIPOV Roman (RUS)
			9	0	0		
3	$\frac{0}{0}$	METSOMÄ,,KI Toni (IK)	P1	P2	P3		
			0	0	0		

### TOUR : 3

4	$\frac{0}{0}$	KARJALAINEN Janne (OP)	P1	P2	P3	1	SHARAFETDINOV Imil (RUS)
			0	0	0		
1	$\frac{4}{9}$	SHARAFETDINOV Imil (RUS)	P1	P2	P3		
			9	0	0		
5	$\frac{0}{4}$	UOTILA Olli (FIN)	P1	P2	P3	2	YUSIPOV Roman (RUS)
			4	0	0		
2	$\frac{3}{4}$	YUSIPOV Roman (RUS)	P1	P2	P3		
			4	0	0		

### TOUR : 4

3	$\frac{0}{0}$	METSOMÄ,,KI Toni (IK)	P1	P2	P3	1	SHARAFETDINOV Imil (RUS)
			0	0	0		
1	$\frac{4}{8}$	SHARAFETDINOV Imil (RUS)	P1	P2	P3		
			8	0	0		
4	$\frac{0}{0}$	KARJALAINEN Janne (OP)	P1	P2	P3	5	UOTILA Olli (FIN)
			0	0	0		
5	$\frac{4}{9}$	UOTILA Olli (FIN)	P1	P2	P3		
			9	0	0		

### TOUR : 5

2	$\frac{4}{1}$	YUSIPOV Roman (RUS)	P1	P2	P3	2	YUSIPOV Roman (RUS)
			1	0	0		
4	$\frac{0}{0}$	KARJALAINEN Janne (OP)	P1	P2	P3		
			0	0	0		
3	$\frac{4}{9}$	METSOMÄ,,KI Toni (IK)	P1	P2	P3	3	METSOMÄ,,KI Toni (IK)
			9	0	0		
5	$\frac{0}{0}$	UOTILA Olli (FIN)	P1	P2	P3		
			0	0	0		

### Classement

Cl	Pays	Nom	Points
1	RUS	SHARAFETDINOV Imil	15
2	RUS	YUSIPOV Roman	11
3	IK	METSOMÄ,,KI Toni	8
4	FIN	UOTILA Olli	4
5	OP	KARJALAINEN Janne	0



**Classement**  
**Vantaa Cup**



STYLE : GR 80 kg

**1 - Or / Gold**



SHARAFETDINOV Imil

**2 - Argent / Silver**



YUSIPOV Roman

**3 - Bronze**



METSOMÄ,,KI Toni

<i>Classement</i>	<i>Nom - Name</i>	<i>Pays - Country</i>	<i>Points</i>
1	SHARAFETDINOV Imil	RUS	15
2	YUSIPOV Roman	RUS	11
3	METSOMÄ,,KI Toni	IK	8
4	UOTILA Olli	FIN	4
5	KARJALAINEN Janne	OP	0



# Feuille de compétition / Competition Sheet

## Vantaa Cup



STYLE : GR 85 kg



### Classement

Cl	Pays	Nom
1	StP	DUGUCHIEV Movsar
2	RUS	SKRYABIN Alexey
3	RUS	BIKBAEV Azamat
3	UKR	SHKRIUBA Iurii
5	ITA	PARISI Fabio
5	EST	LIITMÄ,,E Raido
7	FIN	MÄ,,KINEN Antti
8	EST	TOOM Alo
9	IK	KIVIMÄ,,KI Marko
10	Ä,,H	PÄ-LKKI Leo

### REPECHAGE

#### REPECHAGE FINALISTE 1

1	0 1 ITA	P1 1	P2 0	P3 0
3	4 0 RUS	P1 0	P2 0	P3 0

3 BIKBAEV Azamat (RUS)

Mdaille de Bronze

#### REPECHAGE FINALISTE 2

5	0 5 EST	P1 5	P2 0	P3 0
8	3 0 UKR	P1 0	P2 0	P3 0

8 SHKRIUBA Iurii (UKR)

Mdaille de Bronze



**Classement**  
**Vantaa Cup**



STYLE : GR 85 kg

1 - Or / Gold



DUGUCHIEV Movsar

2 - Argent / Silver



SKRYABIN Alexey

3 - Bronze



BIKBAEV Azamat



SHKRIUBA Iurii

Classement	Nom - Name	Pays - Country
1	DUGUCHIEV Movsar	StP
2	SKRYABIN Alexey	RUS
3	BIKBAEV Azamat	RUS
3	SHKRIUBA Iurii	UKR
5	PARISI Fabio	ITA
5	LIITMÄE Raido	EST
7	MÄKINEN Antti	FIN
8	TOOM Alo	EST
9	KIVIMÄKI Marko	IK
10	PÄLKKI Leo	ÄH



# Feuille de compétition / Competition Sheet

## Vantaa Cup

STYLE : GR 98 kg

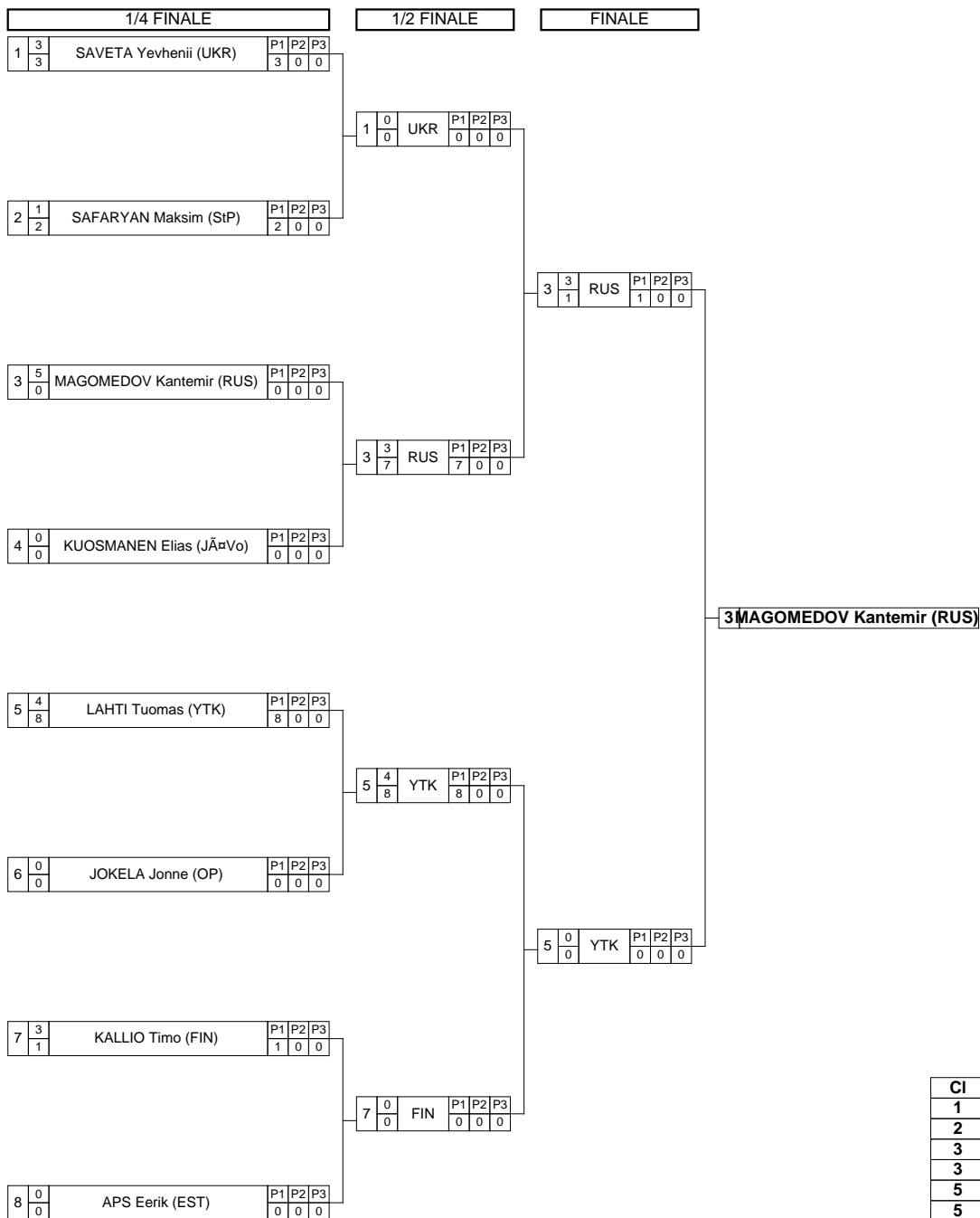

### Classement

Cl	Pays	Nom
1	RUS	MAGOMEDOV Kantemir
2	YTK	LAHTI Tuomas
3	UKR	SAVETA Yevhenii
3	FIN	KALLIO Timo
5	JÄärVo	KUOSMANEN Elias
5	OP	JOKELA Jonne
7	StP	SAFARYAN Maksim
8	EST	APS Eerik

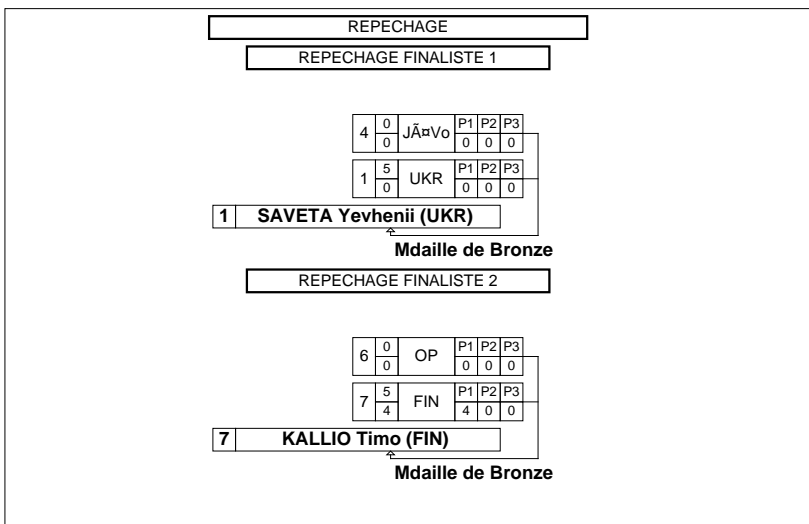



Classement

Vantaa Cup

STYLE : GR 98 kg



1 - Or / Gold



MAGOMEDOV Kantemir

2 - Argent / Silver



LAHTI Tuomas

3 - Bronze



SAVETA Yevhenii



KALLIO Timo

Classement	Nom - Name	Pays - Country
1	MAGOMEDOV Kantemir	RUS
2	LAHTI Tuomas	YTK
3	SAVETA Yevhenii	UKR
3	KALLIO Timo	FIN
5	KUOSMANEN Elias	JÄÄVo
5	JOKELA Jonne	OP
7	SAFARYAN Maksim	StP
8	APS Eerik	EST

